

System Overview

- 1. **Locker Series:** Element Outdoor w/ Light Awning
- 2. **Installation Type:** Linear
- 3. **Color Finish:** tbd
- 4. **Total Package Lockers:** 4
- 5. **Total Dry Cleaning Lockers:** 0

Site Preparation Requirements (Provided by Others):

- 1. Electrical and Internet junction boxes must be installed with bottom of the junction box at 87" FFF - junction boxes must be surface mounted
- 2. System dimensions shown should be verified in the field to confirm the system fits within the desired space
- 3. Each locker module has a typical dimension tolerance of +/- 1/8"
- 4. Actual Locker Height is: 85-1/2" - 87" (range due to adjustable leveling feet)
- 5. Actual Locker Depth is: 34"

Module/Tower Count	
Module	Qty.
ELOM04A-LT	1
ELOM08A-LT	0
ELOM09A-LT	0
ELOM10A-LT	0
ELOM13A-LT	0
ELOM16A-LT	0
ELOK11A-PC-LT	0
ELOM04A-DCL-LT	0
Total:	1

Locker Compartment Information (inches)				
Type	Qty.	Height	Width	Depth
1-High	0	4.8	13.5	22.5
2-High	0	10.2		
3-High	0	15.6		
4-High	0	21.0		
5-High	0	26.4		
6-High	4	31.8		
D6-High	0	31.8		
Total:	4			

DO NOT SCALE OFF THIS DRAWING

ELEVATION: Front View / Profile Elevation 1			
PROJECT NAME: Product Cutsheet		DRAWN BY: Package Concierge	
CREATED: 08/23/2019	LOCATION: Manhattan ,KS	 packageconciierge.com <small>Manufactured by Florence Corporation</small>	
INSTALL BY: N/A	REFERENCE NO:		
DRAWING NO. ELOM04A-LTCS	SHEET 1		
APPROVED SIGNATURE:		PRINTED NAME/DATE:	

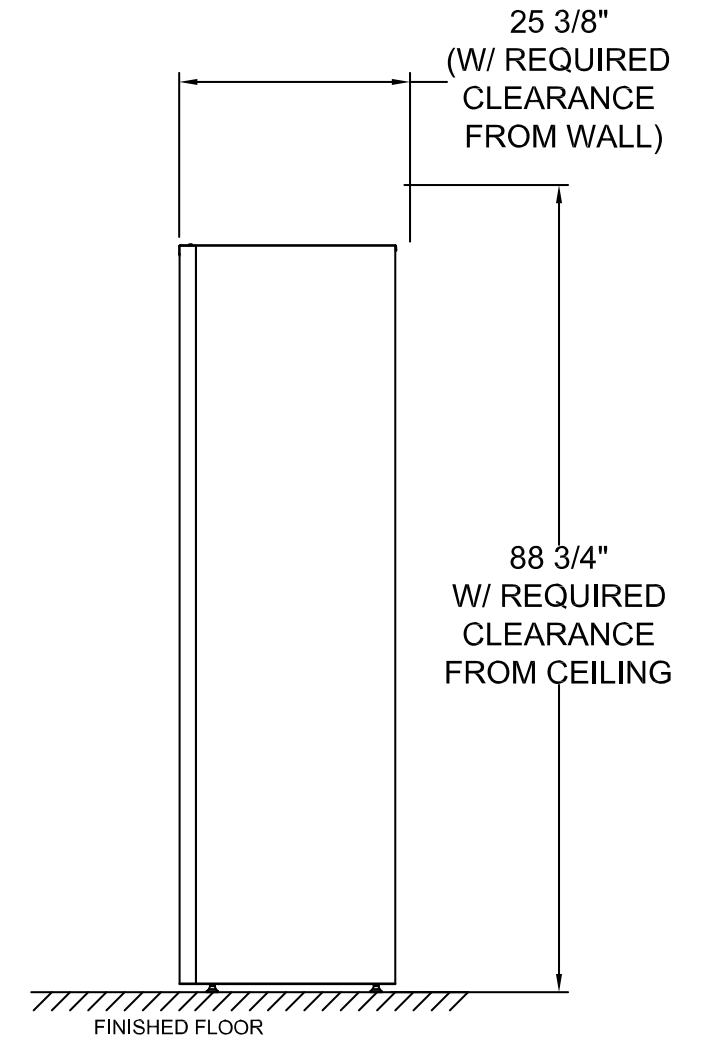
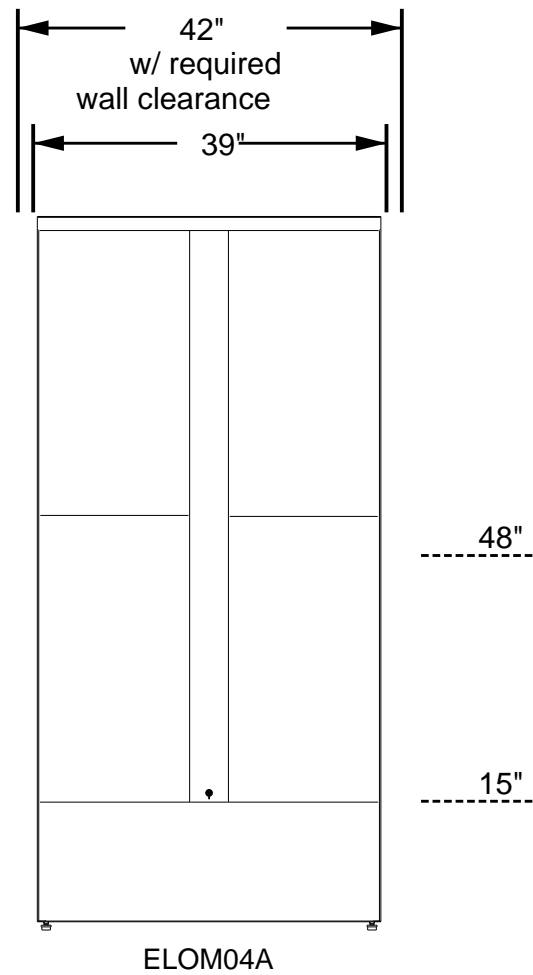

System Overview

- 1. **Locker Series:** Element Outdoor
- 2. **Installation Type:** Linear
- 3. **Color Finish:** tbd
- 4. **Total Package Lockers:** 4
- 5. **Total Dry Cleaning Lockers:** 0

Site Preparation Requirements (Provided by Others):

- 1. Electrical and Internet junction boxes must be installed with bottom of the junction box at 87" FFF - junction boxes must be surface mounted
- 2. System dimensions shown should be verified in the field to confirm the system fits within the desired space
- 3. Each locker module has a typical dimension tolerance of +/- 1/8"
- 4. Actual Locker Height is: 82-1/4" - 83-3/4" (range due to adjustable leveling feet)
- 5. Actual Locker Depth is: 23-7/8"

Module/Tower Count	
Module	Qty.
ELOM04A	1
ELOM08A	0
ELOM09A	0
ELOM10A	0
ELOM13A	0
ELOM16A	0
ELOK11A-PC	0
ELOM04A-DCL	0
Total:	1

Locker Compartment Information (inches)				
Type	Qty.	Height	Width	Depth
1-High	0	4.8	13.5	22.5
2-High	0	10.2		
3-High	0	15.6		
4-High	0	21.0		
5-High	0	26.4		
6-High	4	31.8		
D6-High	0	31.8		
Total:	4			

DO NOT SCALE OFF THIS DRAWING

ELEVATION: Front View / Profile Elevation 1			
PROJECT NAME: Product Cutsheet		DRAWN BY: Package Concierge	
CREATED: 08/23/2019	LOCATION: Manhattan ,KS	 packageconciierge.com <small>Manufactured by Florence Corporation</small>	
INSTALL BY: N/A	REFERENCE NO:		
DRAWING NO. ELOM04ACS	SHEET 2		
APPROVED SIGNATURE:		PRINTED NAME/DATE:	